



ISABELLENHÜTTE

Current sensing in automotive electronic systems: selecting the right resistors

Author: Dr. Ullrich Hetzler
Leiter Forschung & Entwicklung
hetzler@isabellenhuette.de

Isabellenhütte Heusler GmbH & Co. KG
Eibacher Weg 3-5, 35683 Dillenburg
Tel.: 02771 / 934-0

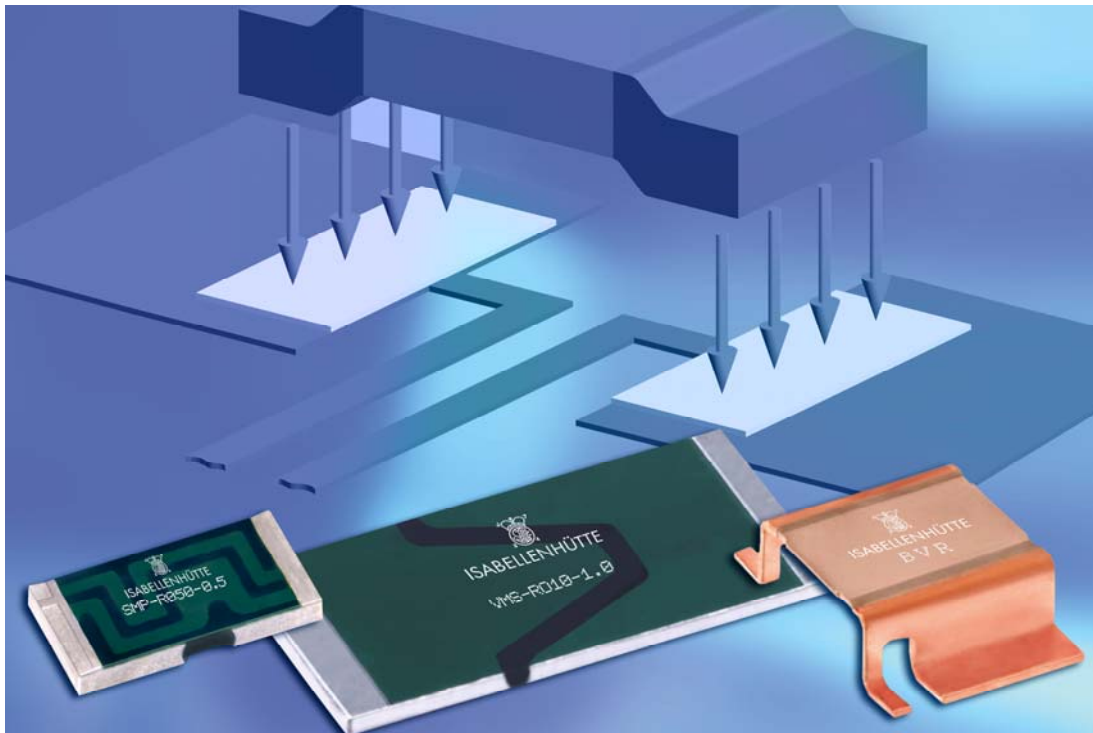

WHITEPAPER



Current sensing in automotive electronic systems: selecting the right resistors

Achieving the best possible measuring results on the smallest of space is one of the most common requirements of the automotive industry to automotive electronic systems. This is of advantage for shunt technology. However, the right resistor cannot be found by comparing datasheets, because structure and material lead to very different results in practical use. The most important parameters for best design are described here using calculation examples.

The current measuring resistor, the so-called shunt, has been known for decades. However, our current possibilities deviate strongly from those we once had. By now, very low-ohmic, almost error-free resistors and a highly precise collection of measured values are available. This opens up fields of application for developers that no one would have thought possible 10 years ago.

The control and regulation of actuators in the vehicle mostly requires currents between 1 and 100 A. But, in special cases (e. g. the lambda sensor heating), there are temporary currents of 2 - 300 A, or even up to 1500 A in the case of the cranking current. In the area of battery and power management, the situation is even more extreme, since the continuous currents during vehicle operation are between 100 and 300 A, while in the idle state, only few mA must be measured accurately.

Basics of recording currents through a resistor

According to Ohm's law, when detecting a current via a resistor, the potential difference is interpreted as a direct measure of the current. In connection with resistance values above 1 Ohm and currents of several 100 mA, this is not critical. However, the situation changes entirely if currents in a range above 10 to 20 A are involved, because then, the power loss ($P=R \cdot I^2$) in the resistor cannot be neglected anymore. An attempt can be made to limit the power loss through lower resistance values, but since the measuring voltage is also lowered, the resistance value is often limited by the resolution of the evaluation unit.



ISABELLENHÜTTE

In general, the following applies to the voltage measured on the resistor:

$$\mathbf{U = R * I + U_{th} + U_{ind} + U_{iext} + \dots}$$

U_{th} = thermal EMF (electromotive force, thermoelectric voltage)

U_{ind} = induced voltage

U_{iext} = voltage drop on power supply

In these cases, the error voltages not caused by a current flow can completely distort the accuracy of the measurement, hence the designer should know the causes and should minimise their effects through careful layout design and especially by the choice of appropriate components.

An electrical resistor can basically be made of any conductive material. However, such a component is probably not suitable as a current sensor, since the resistance value will be dependent on parameters such as temperature, time, voltage, frequency, etc.

$$\mathbf{R = R (T, t, P, Hz, U, A, \mu, \rho, \dots)}$$

Since the ideal current sense resistor is absolutely independent of these parameters of course does not exist, the real resistor is described by the characteristics listed in the table, such as tcr, long-term stability, thermal EMF, load capacity, inductance, linearity, etc.

Some of these characteristics are essentially material-dependent, others are strongly influenced by the design and others yet are determined in the production process, as described in the table.



ISABELLENHÜTTE

Characteristics/Requirements Material Size Process

Low tcr	xxx	x	x
High long-term stability	xxx	x	xx
Low thermal EMF	xxx		
Low inductance	x	xxx	
High accuracy			xxx
High load capacity	x	xxx	
Small thermal resistance		xxx	x
4-terminal design		xxx	
Low total resistance		xxx	x
High security	xx	x	x
Low price	x	xx	xxx

xxx = great influence

xx = medium influence

x = small but considerable influence

Resistor Alloys

Already more than 100 years ago (1889), Isabellenhütte from Dillenburg developed the precision resistance alloy Manganin, whose outstanding characteristics have since been used as a basis for precision measurement technology all over the world, for instance in standard resistors. The other alloys Isaohm and Zeranin round off the range of specific resistances at the top and bottom with 132 and 29 $\mu\text{Ohm}\cdot\text{cm}$ respectively. All alloys largely fulfil the material requirements and have successfully been in operation for many years, although Manganin assumes a special role due to its worldwide popularity.

As a reaction to further developments in the field of magnetic materials, Isabellenhütte has set itself the goal in the last 25 years to physically optimise the shunt resistor in order to



ISABELLENHÜTTE

extend the range in which precision current measurements with resistors are rationally usable. At the same time as offset, temperature coefficient and noise of operational amplifiers were improved, the resistance values could be reduced to the lower mOhm range, thus largely eliminating the main problem of the high power loss with large currents ($P=R \cdot I^2$). Simultaneously however, the relative error caused by fault voltages (interferences, thermoelectric voltage, among others) increases at such a strong rate that low inductance and suppression of thermal EMF gain extreme importance.

In the following, the most important parameters will be discussed briefly.

Temperature coefficient (tcr)

The chart shows the typical parabolic temperature curve of Manganin resistors. Since this characteristic is determined only by the material composition, resistors with very high reproducibility and very low batch variation can be produced.

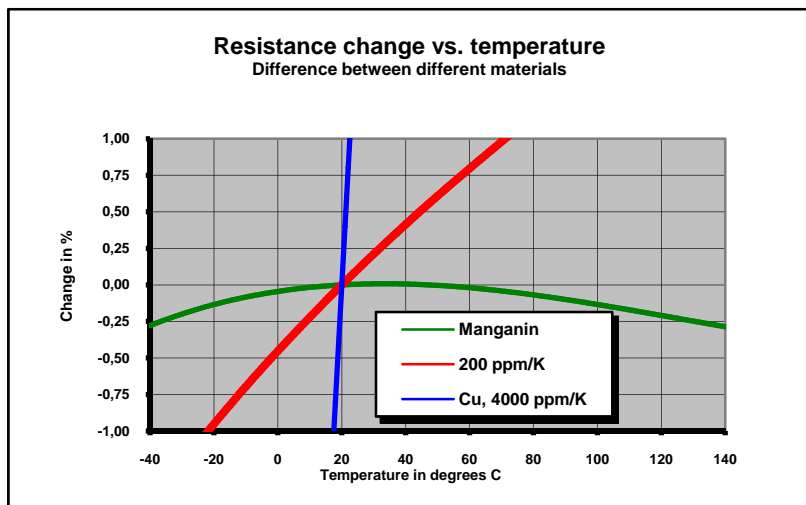

The temperature coefficient is expressed in ppm/K and is defined as follows:

$$tcr = (R(T) - R(T_0)) / R(T_0) \cdot 1 / (T - T_0) = dR / R(T_0) \cdot 1 / R(T_0)$$

where the reference temperature is usually a value of 20 or 25 °C. If the temperature dependence is a curve like with Manganin, it is essential to also state the upper temperature used for the measurement of the temperature coefficient, e. g. tcr (20-60).



ISABELLENHÜTTE

Often thick film resistors with tcr values of several 100 ppm/K are used in the low ohmic range. The red curve shows the temperature drift for a resistor with only 200 ppm/K, even a temperature change of 50 °C is sufficient to exceed the 1% limit. An accurate current measurement is not possible with such resistors. Even more extreme cases are known were well known measurement equipment manufacturers recommended a Cu track on a PC-board as current sense resistor. Because Cu has a tcr of 4000 ppm/K (or 0.4%/K), a temperature change of only 2.5 °C is enough to leave the 1% limit already causes a drift of 4%.

Thermal EMF (U_{th})

A so-called thermoelectric voltage develops on the contact between different materials if it is warmed up or cooled down slightly. This effect is especially important for low ohmic resistors, since the voltages measured here are generally very small and therefore thermoelectric voltages in the μV range can strongly distort the result.

Even today, the resistor material Konstantan known from lectures and textbooks is very often used in the production of wire-wound and punched shunts. Although it has quite a good tcr, the thermal EMF versus Cu is extremely high at approx. 40 $\mu\text{V}/\text{K}$. A temperature difference of only 10 °C, an error voltage of 400 μV is generated that falsifies a measurement result with a 1 mOhm-resistor of 4 A by 10%. The situation is even more extreme if one considers that depending on the size, the mostly neglected Peltier effect can build up a temperature difference of more than 20 °C through reciprocal warming up or cooling down of the contacts (in extreme cases, a remelting of the solder connection on one side of the resistor was observed). Even with a constant current flow the built-up of the temperature difference due to the Peltier-effect the measured total voltage simulates a non constant current. After turning off the current, an apparent current flow is measured that disappears with the time of the temperature equalization. Depending on the design or the resistance value, this error can be as big as a few percent or several A. The precision resistance alloys mentioned above are thermoelectrically exactly matched to Cu, so that these effects can be completely neglected and for instance a 0.3 mOhm resistor delivers a voltage of less than 1 μV (corresponding to 3 mA) immediately after turning off a current of 100 A.

Long-term stability

Stability over time is extremely important for any sensor, since even after years in operation, the user still wants to be able to rely on an earlier calibration. This means that the materials of the resistor have to be corrosion-resistant and must not go through any metallurgic transformations during their lifetime. The alloys Manganin, Zeranin and Isohm fulfil these requirements as homogeneous mixed crystal alloys that additionally have been carefully annealed and stabilised and are therefore available in their thermodynamic basic state. Such alloys deliver possible stability values in the ppm-range per year, which Isabellenhütte has impressively been proving for over 100 years with its standard resistors used as international reference.



ISABELLENHÜTTE

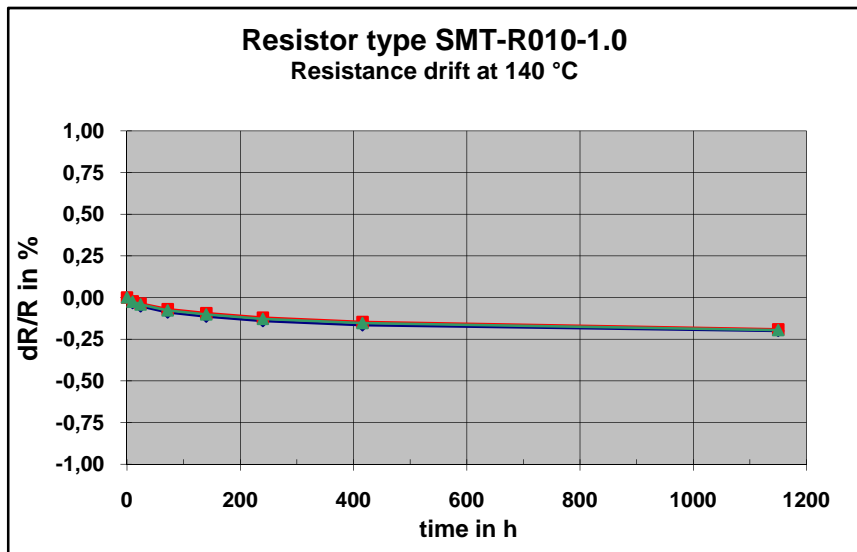

The chart shows a typical behaviour of a real SMD resistor that is annealed at 140 °C for more than 1000 hours. The slight drift of approx. -0.2% is caused by the curing of lattice defects caused by minor deformations during production and shows that the components are further stabilised, i.e. are progressively getting better. Since the speed of the drift strongly depends on the temperature, already at 100 °C, this effect is virtually non-detectable.

Four-terminal connection technology

In the case of low ohmic resistors, the influence of the current terminations can often not be neglected. Therefore sense terminations should be used to detect the voltage drop directly on the resistor material.

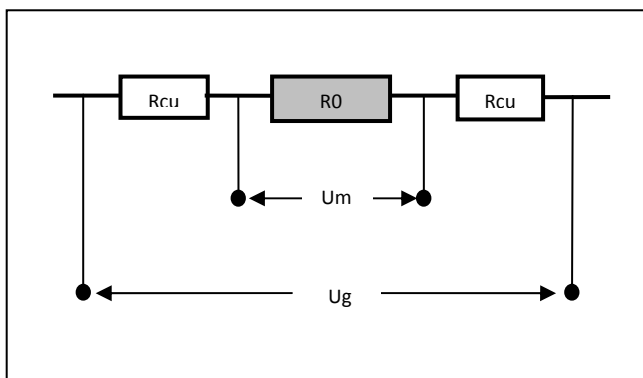

Total resistance : $R_0 + 2 \cdot R_{cu}$

4-terminal resistance : R_0

Examples:

Cu-wire 0.3 mm, 10 mm length

⇒ $R_{cu} = 2.4 \text{ m}\Omega$

Cu-conductor 4 mm*0.2 mm*35 μm

⇒ $R_{cu} = 10 \text{ m}\Omega$



ISABELLENHÜTTE

The examples show that very large errors can occur in the case of faulty construction of the resistor or layout errors. The Cu connecting wires of the above two-terminal resistor account for 24% of the total resistance of a 10 mOhm resistor and just a short piece of a PC-board Cu-track of 4 mm length would already distort the resistance by 100%.

The additional resistance of current terminations can be eliminated with a trimming process of the total resistor but the influence on the tcr is still present.

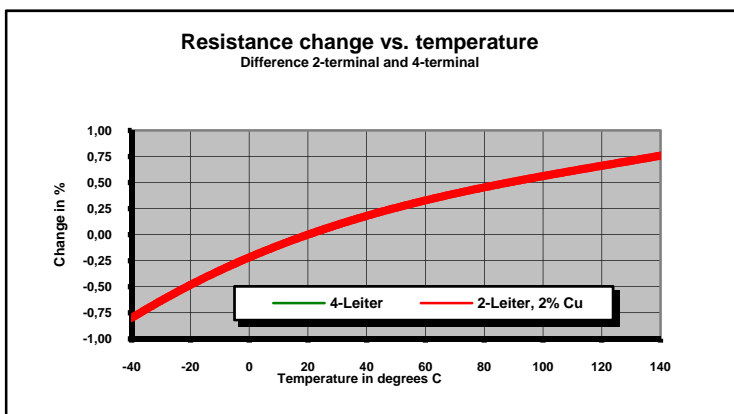

Although in this example, the proportion of Cu is extremely small at only 2% (as opposed to 24% in the example above) the tcr increases from close to zero to approx. + 80 ppm/K.

This means that the practice of stating the tcr of the resistance material in the datasheet of a low ohm resistor is absolutely unacceptable and nonsense.

Resistors made of electron beam welded composite material Cu-Manganin-Cu actually have such a low termination resistance that with a suitable layout, it is possible to use a two-terminal resistor again, since the four-terminal connection is now realised by a suitable PC-board layout. However, during the design of the layout, care must be taken that the current flow in the resistor does not touch the voltage connections (sense lines). If possible, the sense lines should be connected to the current terminals from inside the resistor in form of a micro strip line.

High load capacity

Since the heat conductivity of resistor materials compared to Cu is relatively weak and the resistors mostly use etch structured foils of a thickness between 20-150 μm , it is not possible to dissipate the heat via the resistance material into the terminals. In the case of Isa-Plan resistors, a thin, heat conductive adhesive is therefore used to bond the resistor foil onto a substrate that also has good heat conductive properties (Cu or Alu). In this way, the heat is very effectively dissipated to the outside via the substrate and the contacts, which is ultimately reflected in a comparatively very low internal heat resistance (typically 10-30 K/W).



ISABELLENHÜTTE

This in turn leads to the resistors being able to cope with maximum power up to a very high terminal temperature, i.e. the derating starts at a very high temperature. At the same time however, the maximum temperature in the resistor material is kept low, thus considerably improving the long-term stability under load and the tcr-dependent reversible resistor change.

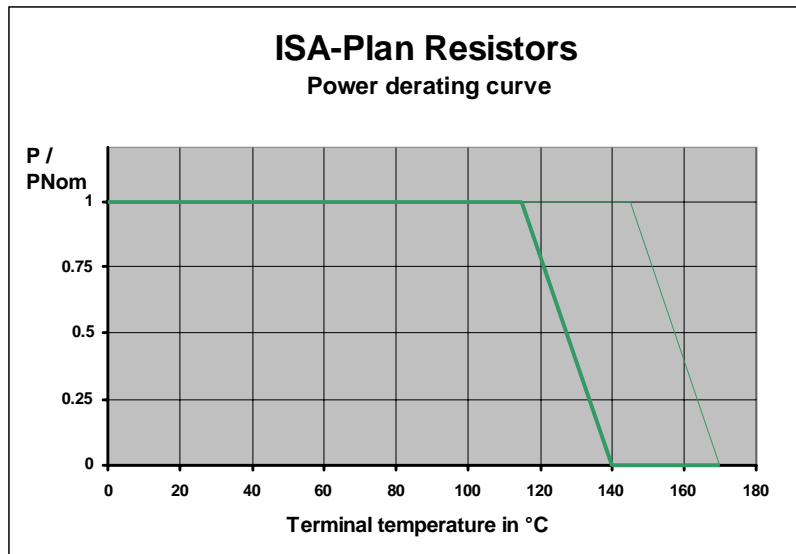

In the extremely low ohmic resistors using the composite material, the Manganin cross-section and hence the mechanical stability is so big that no substrate is necessary. This also means that the heat conductivity of the resistor material is sufficient to achieve comparatively low heat resistances. For the 1 mOhm resistor this is approx. 10 K/Watt and for the 100 μ Ohm resistor it is even 1 K/Watt.

Low inductance

Since it is necessary to measure and control switch mode currents in many applications nowadays, the inductance of the shunt or the shunt circuit is very important. SMD-resistors are produced with low inductance in a flat design with or without closely adjacent meanders. The diamagnetic characteristics of the precision alloys mentioned above, the metallic substrate, as well as the four-terminal connection further contribute to a low inductance.

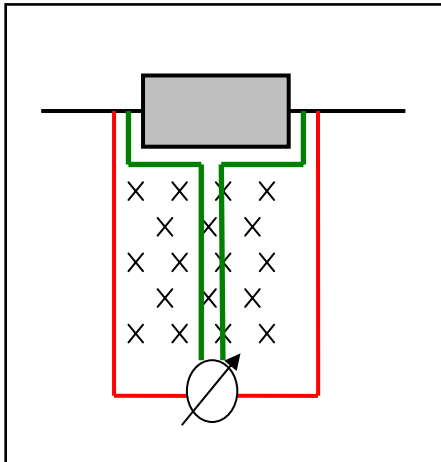

However, since the sense connectors on the PC-board and the resistor form an antenna structure, in which the magnetic field generated by the current flow and other external magnetic field produce induced voltages, it is especially important to keep the area enclosed by the sense tracks lines as small as possible. The optimal solution is a strip-line design, i.e. the two lines are led to the amplifier as close as possible to each other or even better on two layers congruently on top of each other. As a result of a bad layout (red lines), this antenna effect can far exceed the influence of the resistor's real inductance.

Low total resistance

Although at high currents and low resistance values a four-terminal design is indicated, the often used solution to punch parts out of a Manganin sheet (fig. a) is not the best solution, because although the four-terminal sensor resistor, its tcr and the thermoelectric voltage are okay, the total resistance is in some cases 2 - 3 times as high as the real sensor resistor.

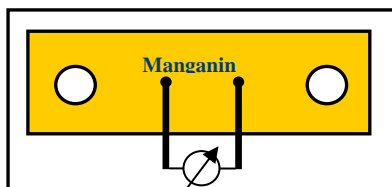

The result is a correspondingly higher, often unacceptable power loss and temperature increase in the resistor. In addition, resistor materials are difficult to connect to Cu via screw and solder joints, which leads to an increased contact resistance and therefore to further losses.

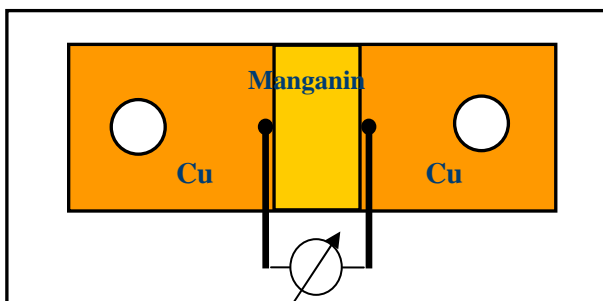

These errors are largely eliminated with the resistors punched out of the composite materials. The total resistance is increased by less than 10% and the customer can as well resort to approved Cu-Cu joining techniques.

Sizes and Applications

For reasons of economy and miniaturisation, SMD-designs with resistor values from 200 μOhm are increasingly being designed for current measurement of up to 100 A in automotive



ISABELLENHÜTTE

vehicles. Below, some sizes, their special features and examples of applications will be shown. All have in common the two-terminal design and the physically optimised structure that allows an absolutely correct measurement in four-terminal technique by a suitable PC-board layout.

VMx-Series:

High-load precision resistors made of the resistor material Zeranin with an extremely small thermal force against copper, below 1 $\mu\text{V/K}$.

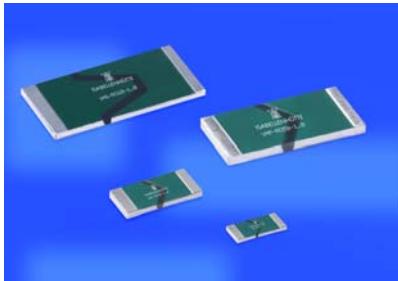

Resistor range	:	5 mOhm to 2 Ohm
Builds	:	2512, 2010, 1206, 0805
Load capacity	:	3; 2; 1; 0.5 Watt
Tolerance	:	up to 0.5; 1; 2; 5 %
Heat resistance	:	up to 20 K/W

Applications:

- Ignition control modules
- Gear control
- Engine management modules
- Door lifter
- Cycled actuator
- Measuring resistors for power hybrids
- Control devices in automotive technology
- Power modules
- Frequency converter
- Switching mains adapters



ISABELLENHÜTTE

SMx-Series:

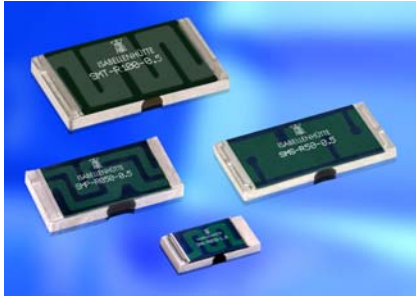

This type series uses a Cu-substrate, which represents heat sink and electric contact at the same time. This enables the complete transfer of the characteristics of Manganin into the component and a high continuous and pulse power as well as a low inductance.

Resistor range	:	3 mOhm to 5 Ohm
Sizes	:	2816, 2512, 2010, 1206
Load capacity	:	5, 3, 2, 1, 0.5 Watts
Tolerance	:	up to 0.5%
Heat resistance	:	up to 10 K/W

Applications:

- Petrol and diesel direct injection
- Transmission controllers
- High pressure head lamp controllers
- Engine management modules



ISABELLENHÜTTE

BVX-Series:

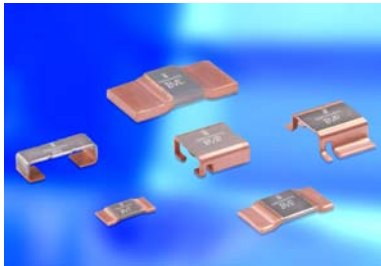

The SMD-resistors punched out of composite material (ISA-Weld) are suitable for high current applications for assembly on the circuit board, on DCB- or MIS-substrates or for welding into lead frames.

Resistor range	: 2 μ Ohm to 4 mOhm
Load capacity	: 3, 5, 7 Watts
Tolerance	: up to 1%
Heat resistance	: up to 2 K/W

Applications:

Switch mode current regulation

- Up to 100 A
- Up to 140 °C ambience
- EMV Level 5
- Effectiveness 94-98%
- Full motor protection
- 12/24/42 V

PWM power controller for

- radiator fan
- interior blower
- electric oil pump
- electric water pump
- DC/DC-converter
- EC/DC-motors



ISABELLENHÜTTE

Data acquisition system for current measurement in automotive vehicles

There is an increasing number of applications in vehicles which require the highly dynamic, accurate and high resolution measurement of currents of several 100 A to over 1000 A and at the same time a good resolution in the mA range. Examples for this are battery and power management in passenger cars and trucks as well as current measurement in electric and hybrid vehicles.

The current and voltage measuring module IVT-A includes a complete 4-channel data acquisition system and a low-impedance resistor for measuring extremely low voltages on shunt resistors. With a 16-bit resolution and many special functions, the system comes very close to the ideal current sensor. On the one hand, it can measure currents up to 1500 A with high dynamics, linearity, and resolution, but on the other hand, it achieves a resolution of few mA for a low sampling rate. The module only requires one supply voltage of 5 V/3 mA and can still measure bipolar signals even below its own supply voltage. In addition to the current measurement, a voltage or temperature measurement can be taken at the same time.

With a special resistor of 2 μOhm , this system can even measure currents of up to 10,000 A at a resolution of less than 1 A and thus advances into an area that has up to now been the exclusive domain of converters.

With a special resistor of 2 μOhm , this system can even measure currents of up to 10,000 A at a resolution of less than 1 A and thus advances into an area that has up to now been the exclusive domain of converters.